

Assembly and Installation Instructions

Carefully select the location of your sign to be sure that it will be readily visible to those for which it is intended. Before installing any sign, be sure that the installation does not obstruct traffic or hamper local utilities, landscape, maintenance, snow-plowing, etc...

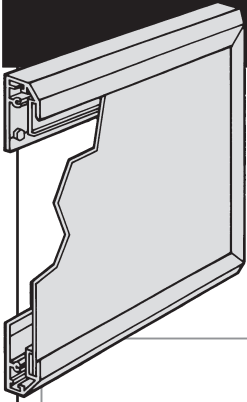

Wall Mount

Note:
Assembly is the same for the DSS-125 and DSS-75.

Step 1

Carefully unpack the frame and panel assembly from the shipping cartons. Lay the unit on the ground (use shipping cartons underneath to avoid damage). The sign should have shipped completely assembled.

Step 2

Plan carefully, it is important to check your clearances before beginning to install DSS-125 wall mount signs. The general idea in mounting these signs is to fasten two or three frame sections to the wall leaving one frame section unfastened for panel installation. This will allow the panel to slide in from the top, bottom, or sides. For maximum support, fasten the longest frame sections when possible.

Determine the direction in which the panel will most easily slide into the frame based on the mounting location of the sign and the clearances surrounding it. Using the assembled sign, level and mark the sign location on the wall.

Continue with Step 3.

Assembly Detail

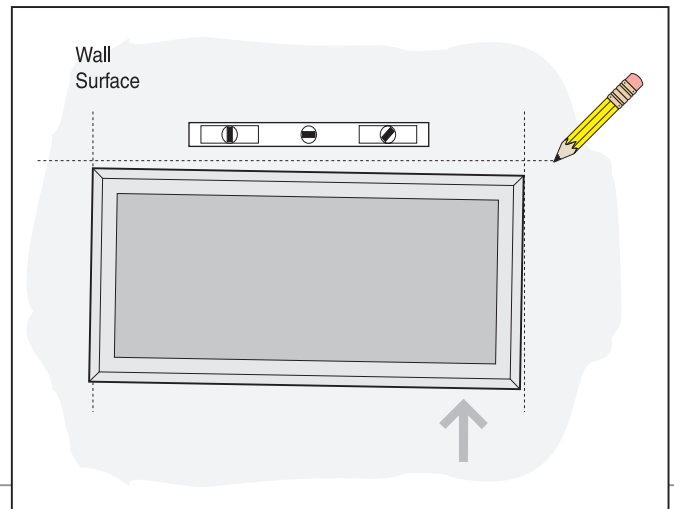
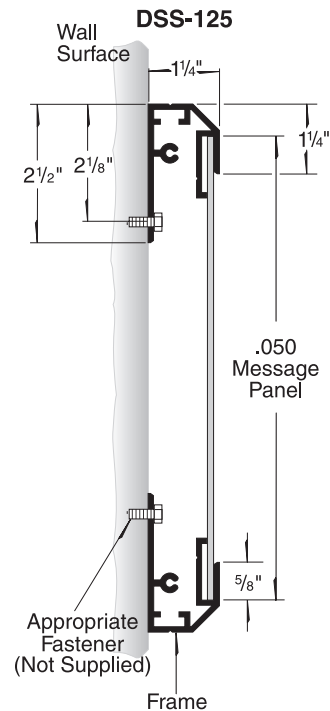

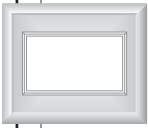

Wall Mount Continued

Step 3

Keeping in mind the clearances surrounding the sign, unfasten the appropriate corner screws and remove one frame section and the message panel. Place the panel and screws safely aside. To keep the sign in square, replace the frame section without the corner screws.

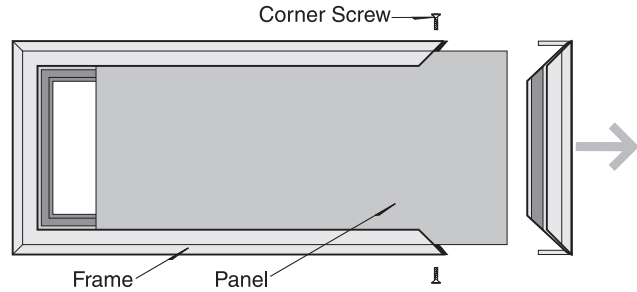

Step 4

Place the sign in position, locate and mark the pre-drilled pilot holes. Secure two or three sections of the frame to the wall surface using appropriate fasteners, not supplied. For maximum support, fasten the longest frame sections when possible.

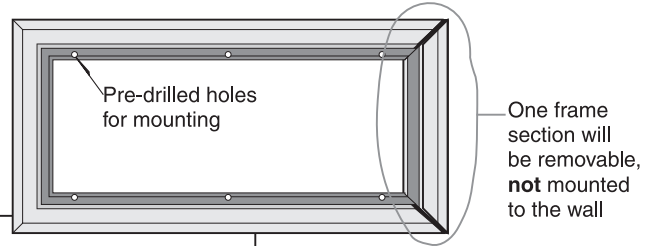

Choose an appropriate fastener type

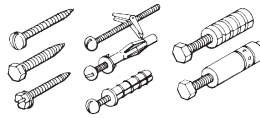

Step 5

Remove the unfastened frame section and carefully slide the message panel into the frame.

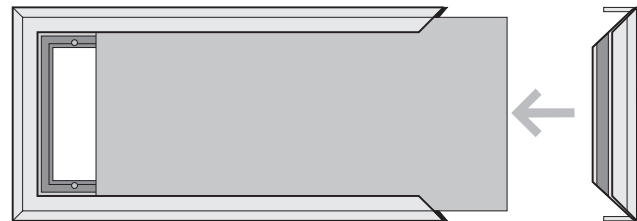

Step 6

Attach the remaining section of frame with the two corner screws removed in Step 3.

