

8" x 8 1/2" Graphic Size

PF Standards

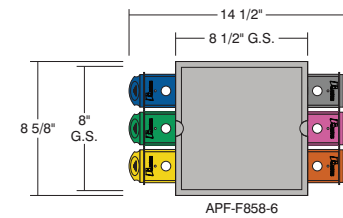
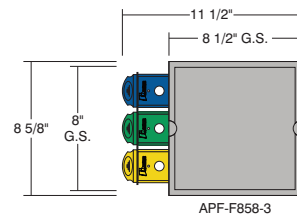
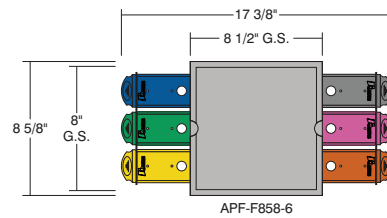
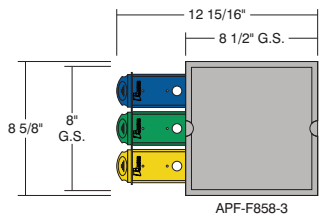
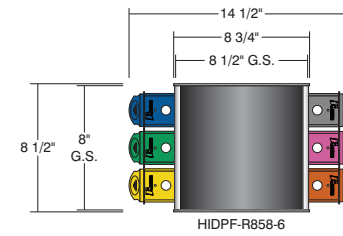
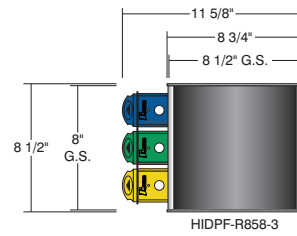
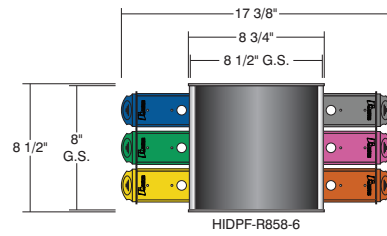
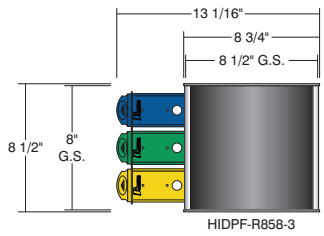
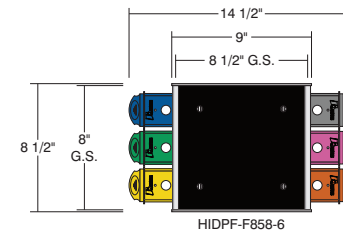
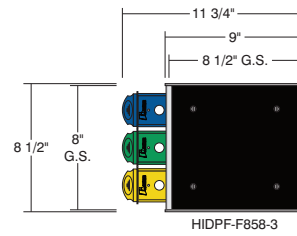
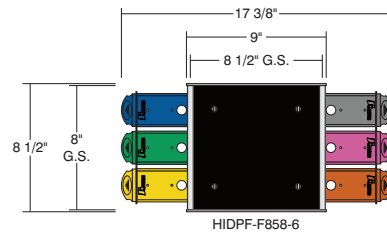
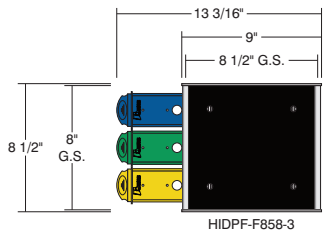

Drawing #	PF Standards
Date	10.8.18
Scale	1 1/2" = 1'
Drawn By	TWG

Approved _____



11" x 8 1/2" Graphic Size

PF Standards

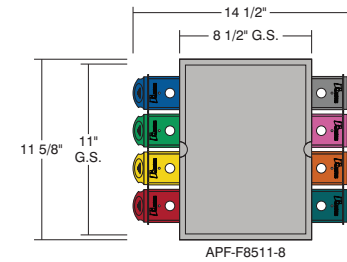
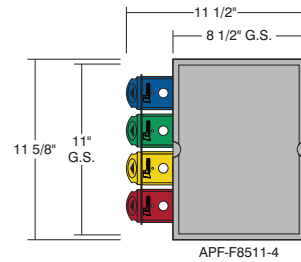
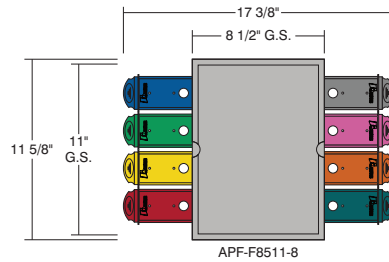
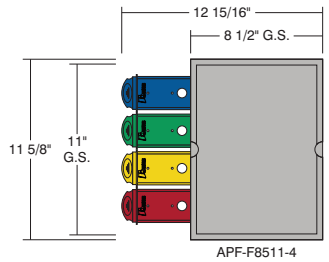
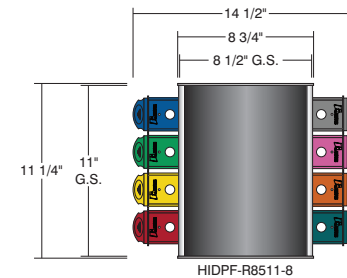
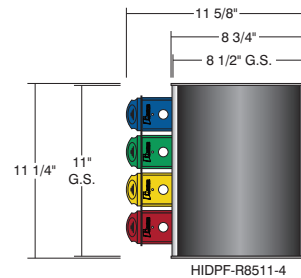
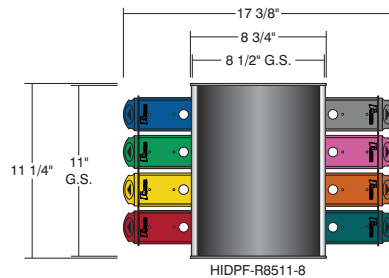
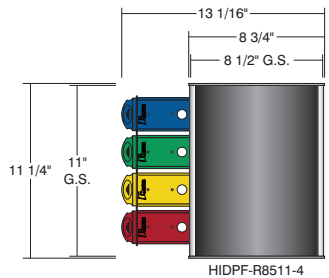
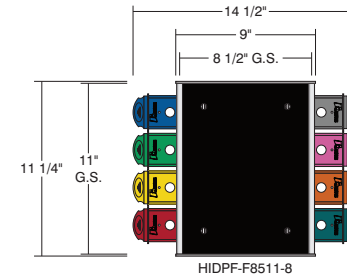
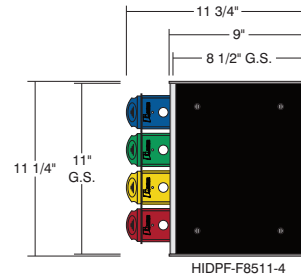
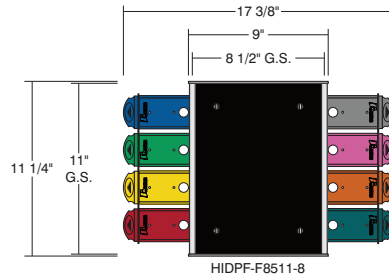
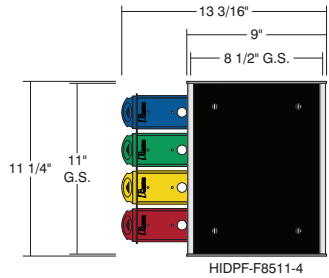

Drawing #	PF Standards
Date	10.8.18
Scale	1 1/2" = 1'
Drawn By	TWG

Approved _____



13" x 8 1/2" Graphic Size

PF Standards

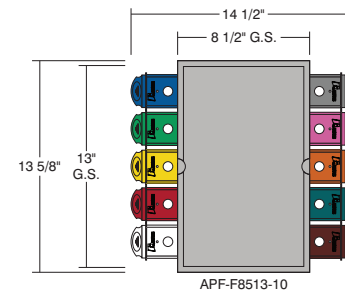
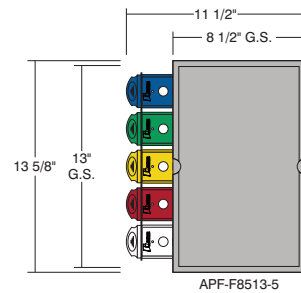
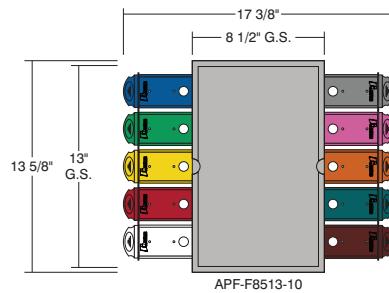
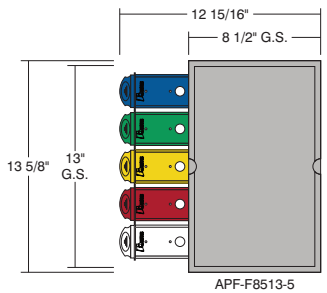
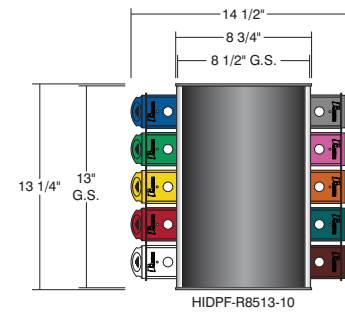
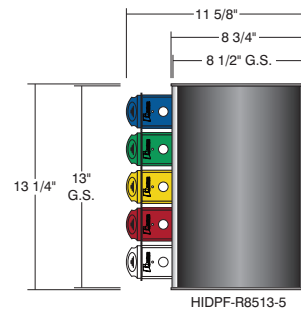
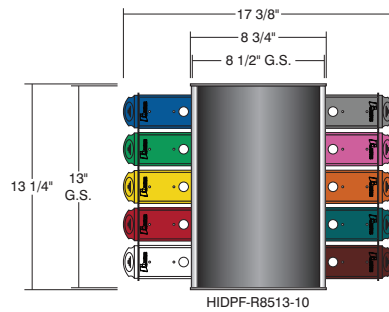
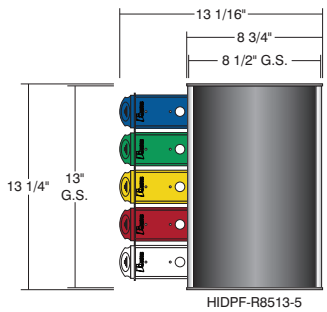
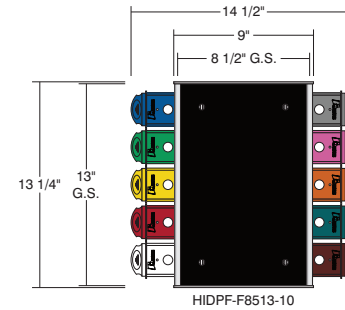
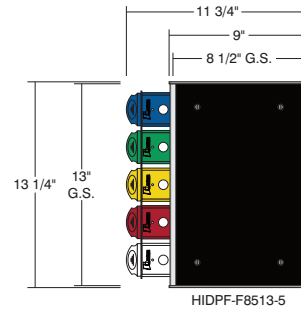
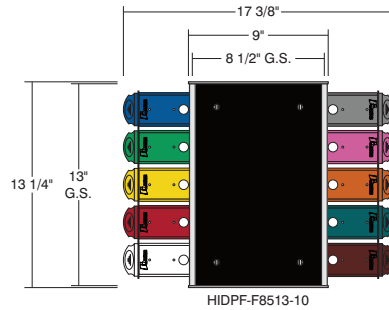
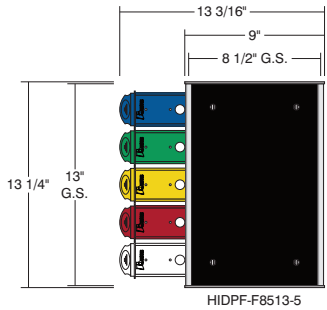

Drawing #	PF Standards
Date	10.8.18
Scale	1 1/2" = 1'
Drawn By	TWG

Approved _____



16" x 8 1/2" Graphic Size

PF Standards

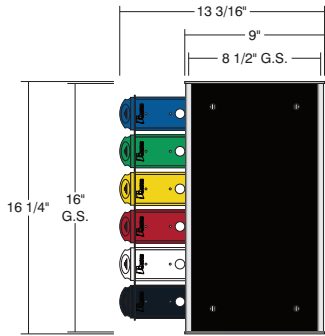

HIDPF-F8516-6

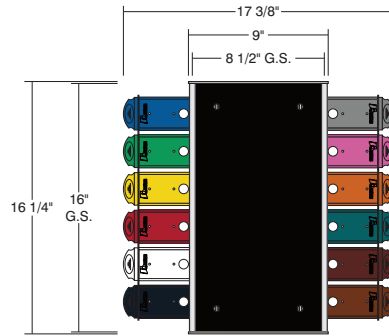

HIDPF-F8516-12

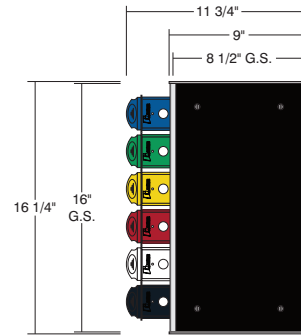

HIDPF-F8516-6

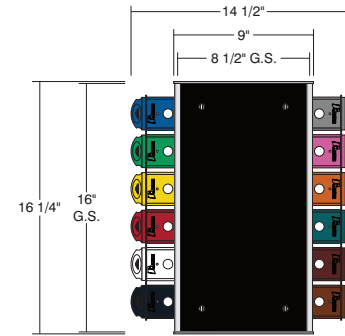

HIDPF-F8516-12

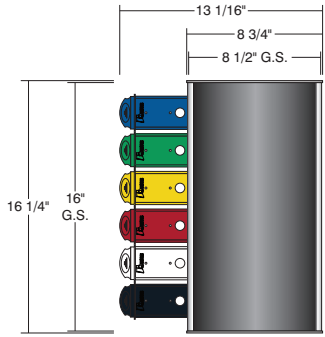

HIDPF-R8516-6

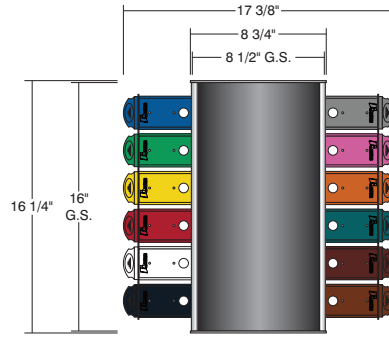

HIDPF-R8516-12

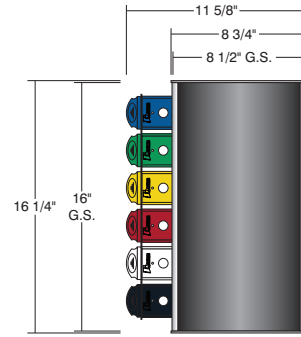

HIDPF-R8516-6

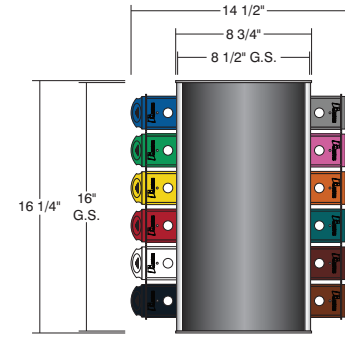

HIDPF-R8516-12

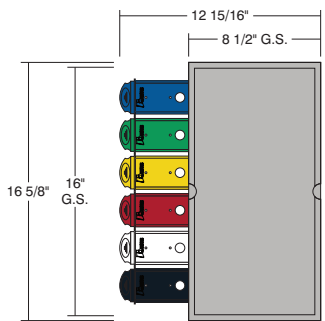

APF-F8516-6

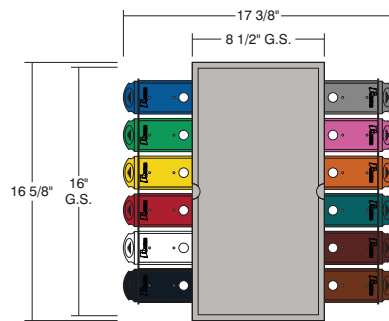

APF-F8516-12

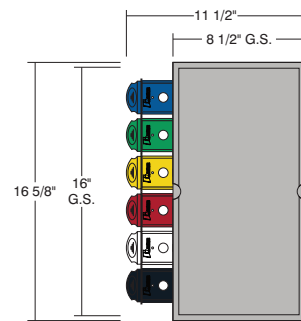

APF-F8516-6

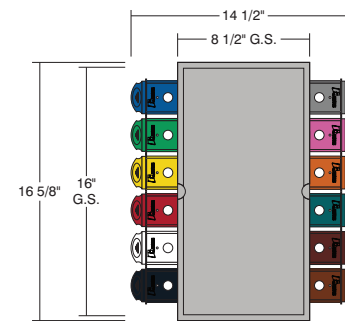

APF-F8516-12

Drawing #	PF Standards
Date	10.8.18
Scale	1 1/2" = 1'
Drawn By	TWG

Approved _____



8" x 6" Graphic Size

PF Standards

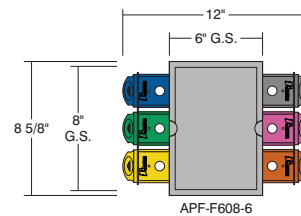
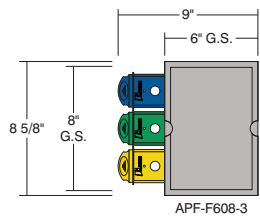
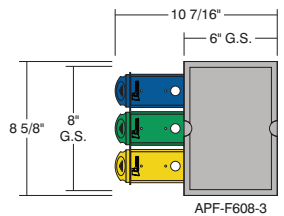
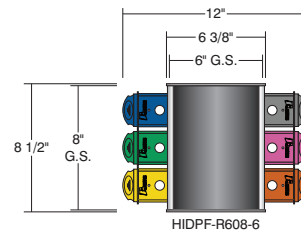
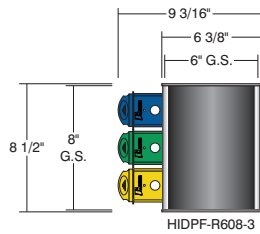
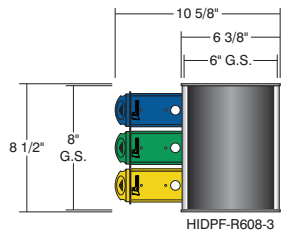
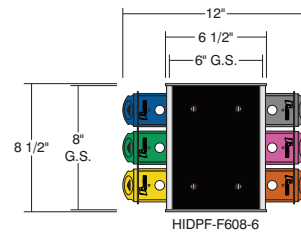
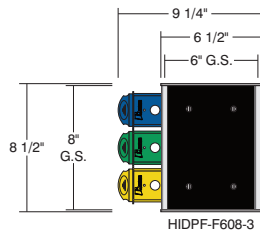
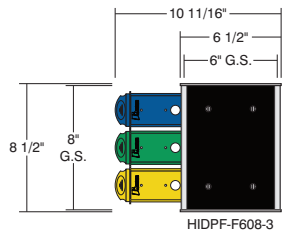

Drawing #	PF Standards
Date	10.8.18
Scale	1 1/2" = 1'
Drawn By	TWG

Approved _____



11" x 6" Graphic Size

PF Standards

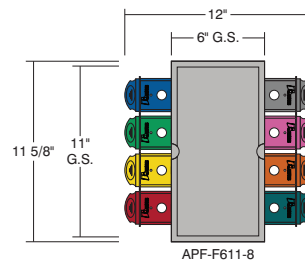
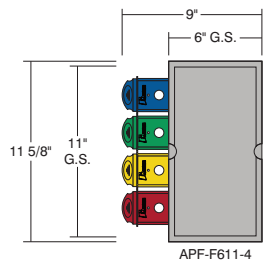
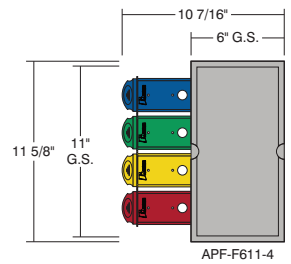
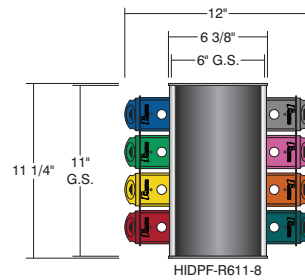
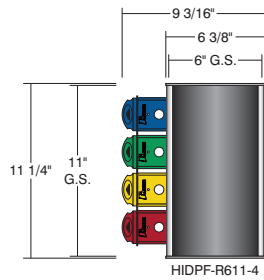
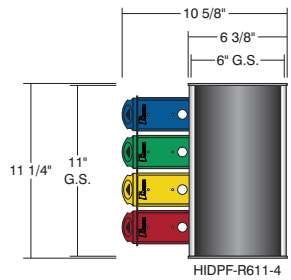
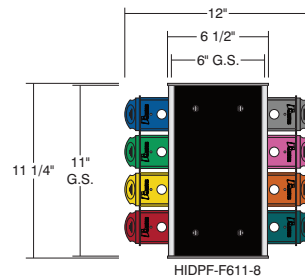
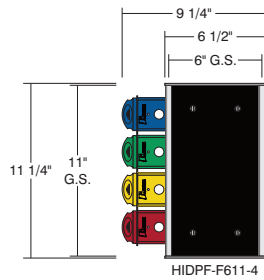
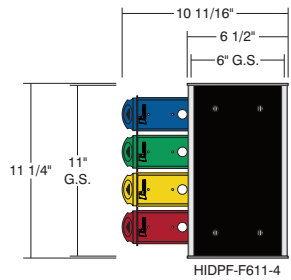

Drawing #	PF Standards
Date	10.8.18
Scale	1 1/2" = 1'
Drawn By	TWG

Approved _____



13" x 6" Graphic Size

PF Standards

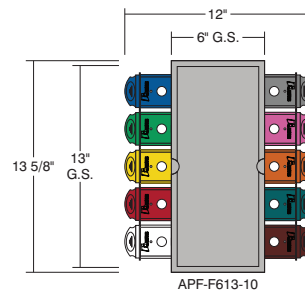
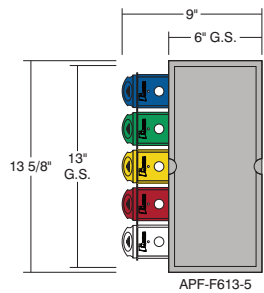
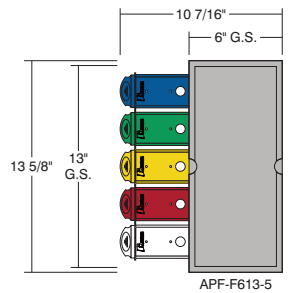
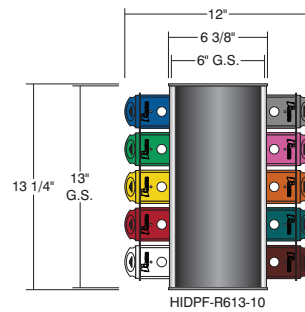
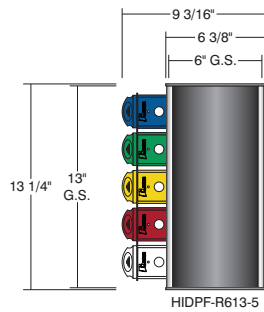
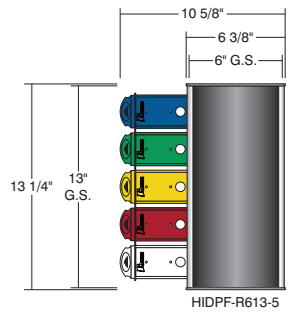
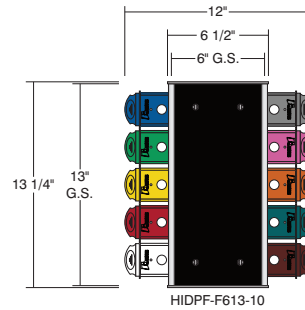
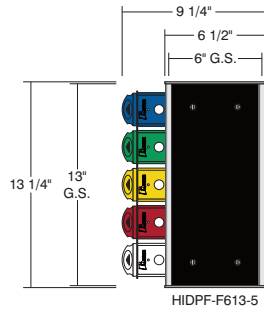
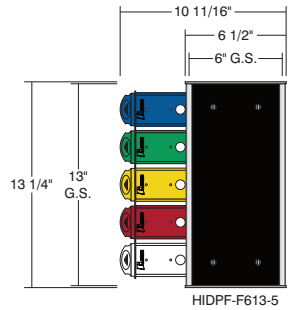

Drawing #	PF Standards
Date	10.8.18
Scale	1 1/2" = 1'
Drawn By	TWG

Approved _____



16" x 6" Graphic Size

PF Standards

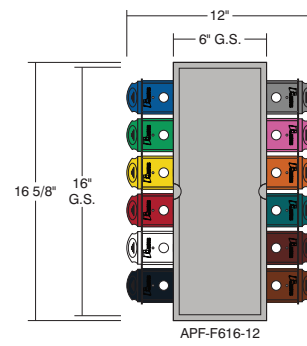
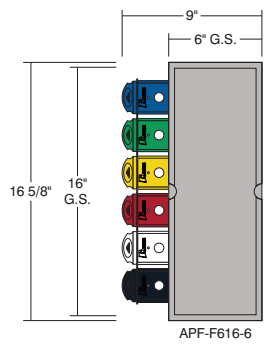
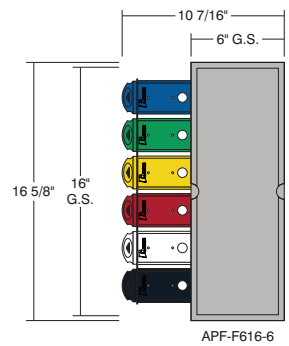
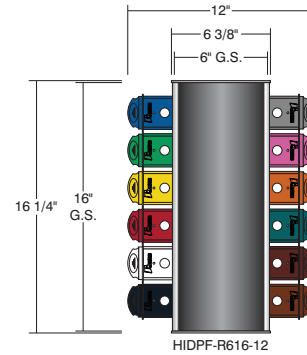
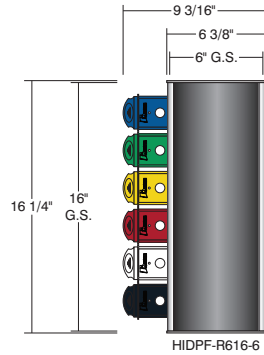
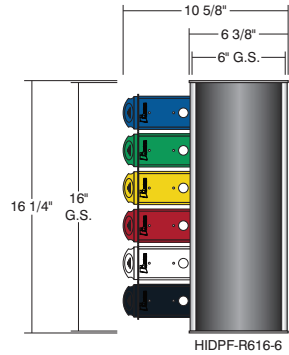
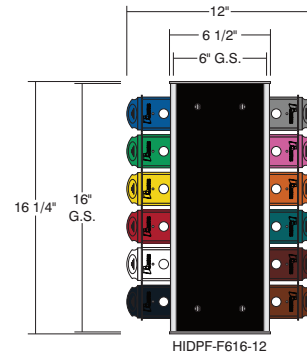
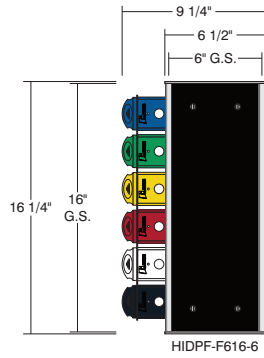
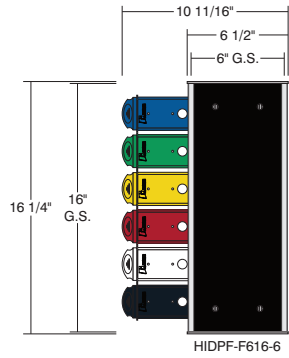

Drawing #	PF Standards
Date	10.8.18
Scale	1 1/2" = 1'
Drawn By	TWG

Approved _____



6" x 8 1/2" Graphic Size

PF Standards

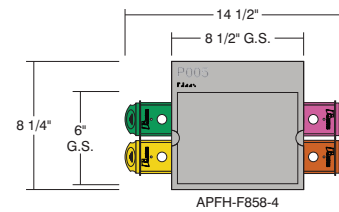
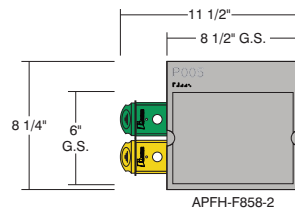
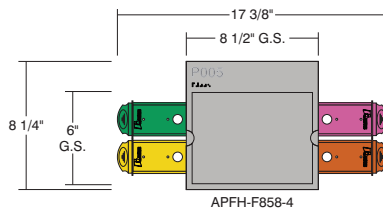
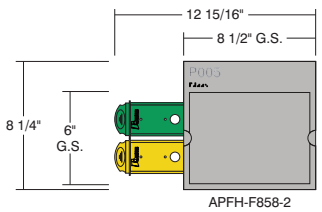
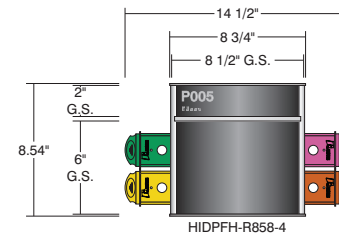
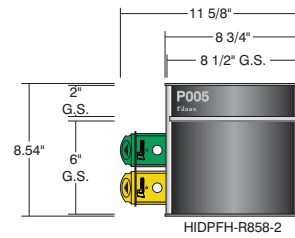
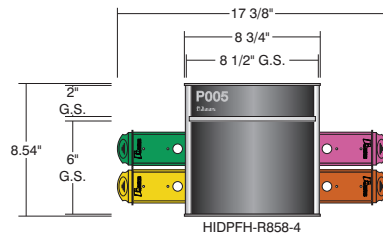
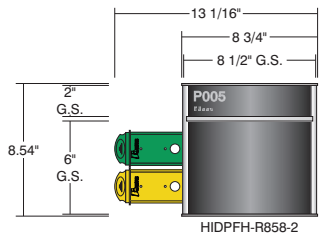
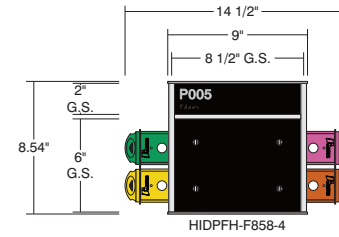
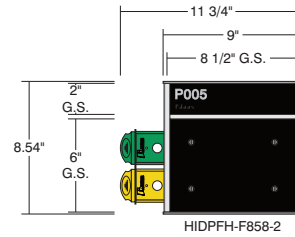
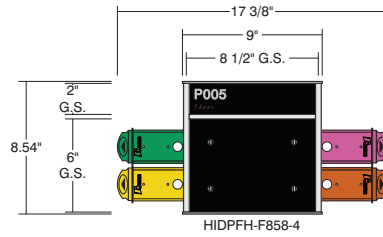
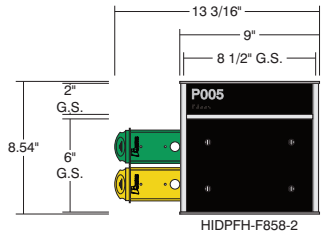

Drawing #	PF Standards
Date	10.8.18
Scale	1 1/2" = 1'
Drawn By	TWG

Approved _____



9" x 8 1/2" Graphic Size

PF Standards

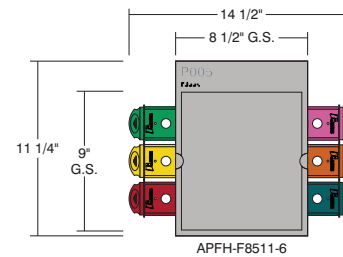
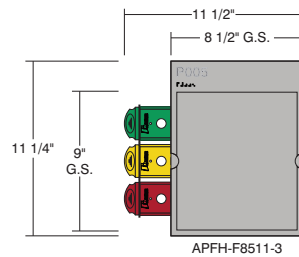
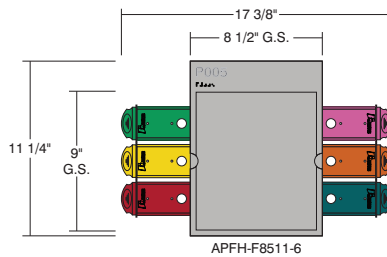
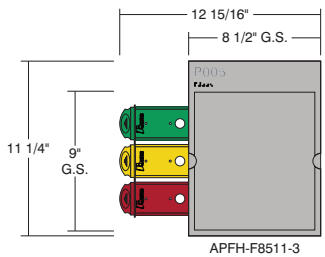
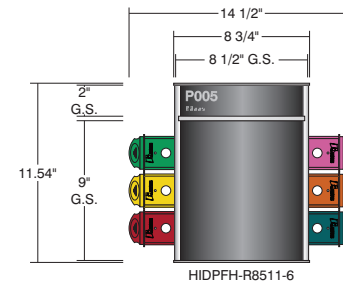
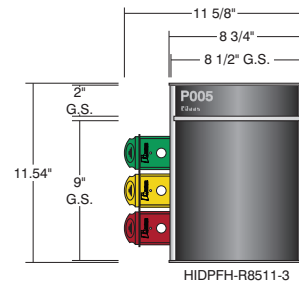
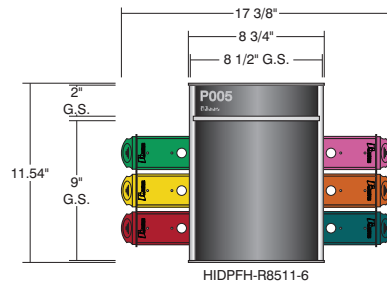
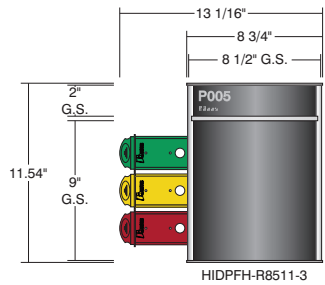
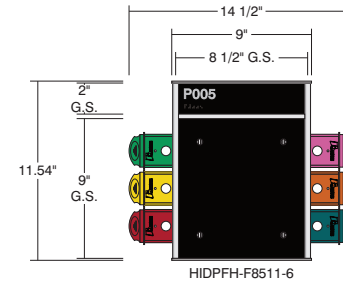
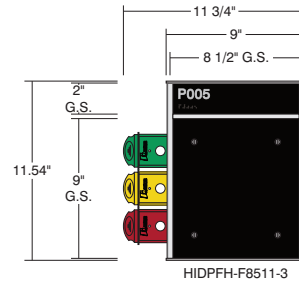
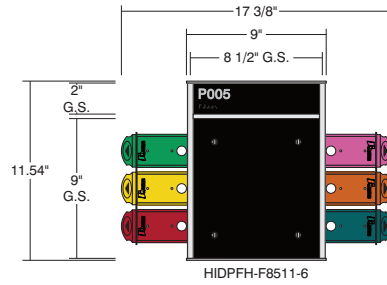
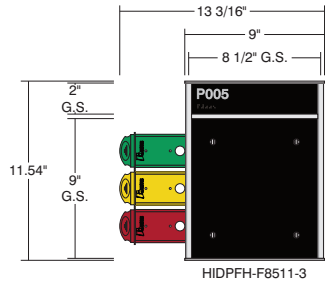

Drawing #	PF Standards
Date	10.8.18
Scale	1 1/2" = 1'
Drawn By	TWG

Approved _____



11" x 8 1/2" Graphic Size

PF Standards

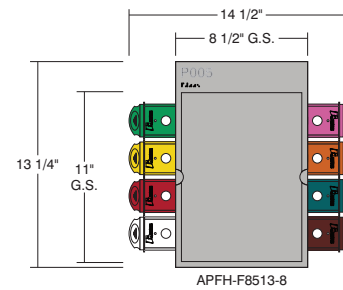
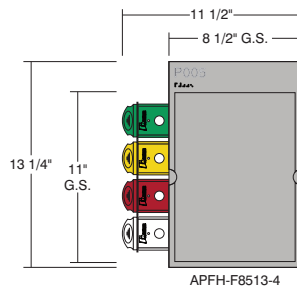
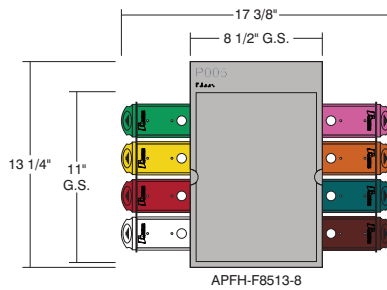
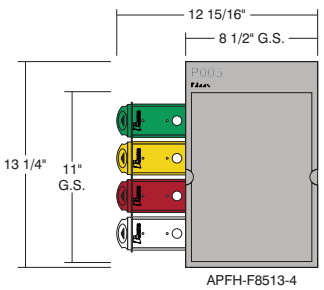
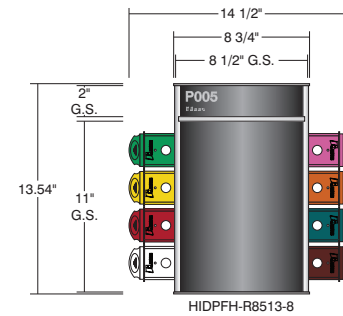
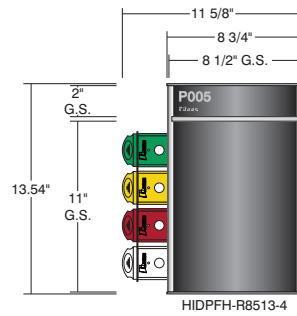
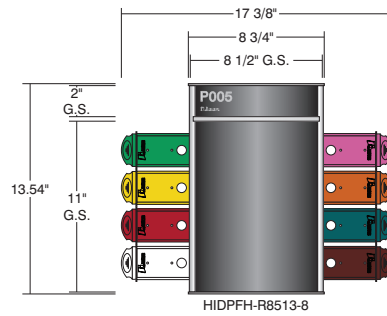
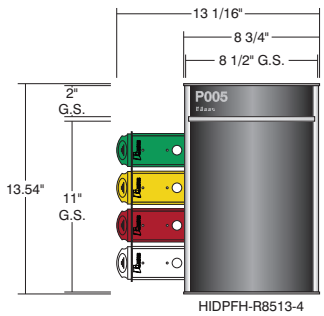
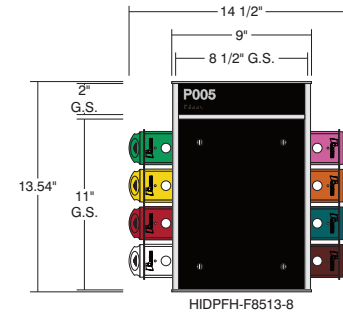
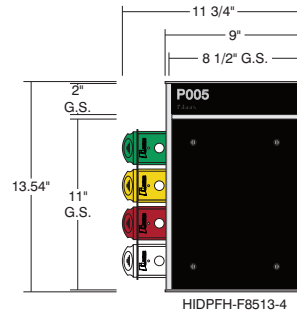
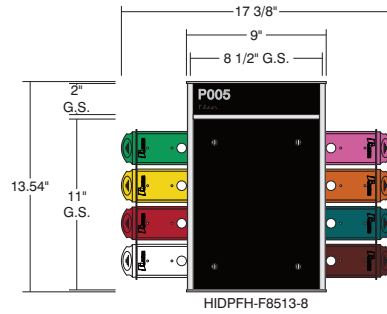
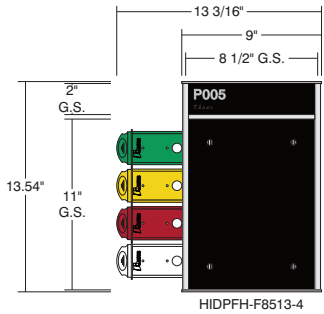

PAGE 11 OF 18

Drawing #	PF Standards
Date	10.8.18
Scale	1 1/2" = 1"
Drawn By	TWG

Approved _____



14" x 8 1/2" Graphic Size

PF Standards

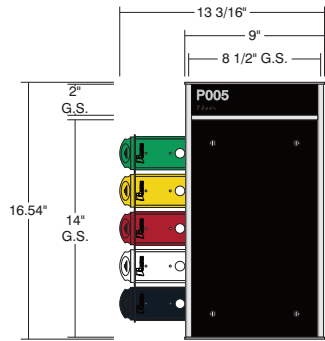

HIDPFH-F8516-5

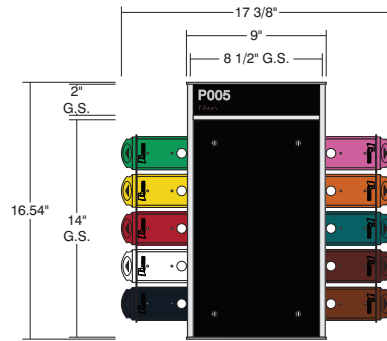

HIDPFH-F8516-10

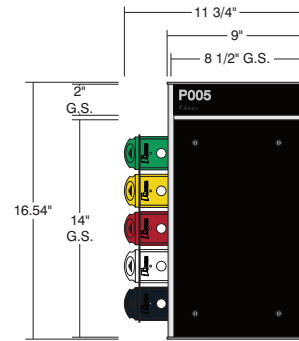

HIDPFH-F8516-5

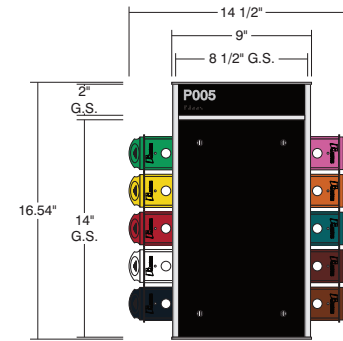

HIDPFH-F8516-10

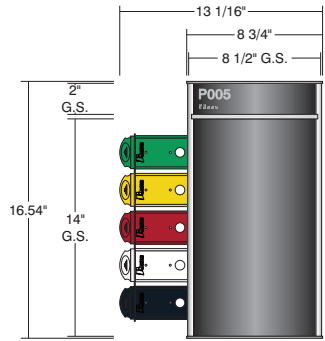

HIDPFH-R8516-5

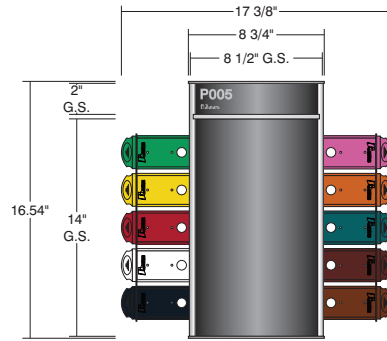

HIDPFH-R8516-10

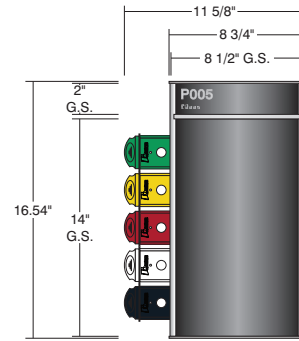

HIDPFH-R8516-5

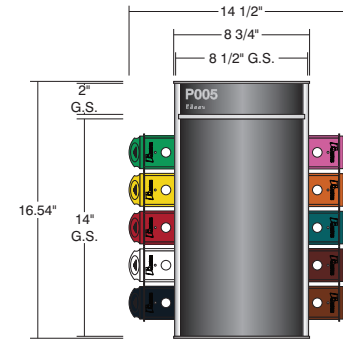

HIDPFH-R8516-10

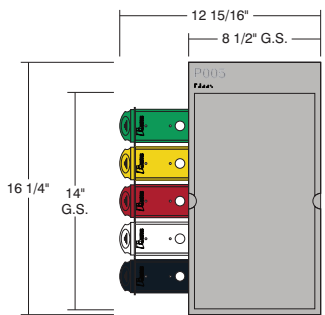

APFH-F8516-5

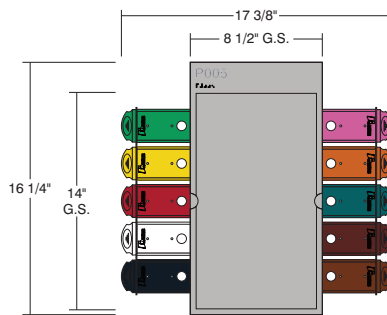

APFH-F8516-10

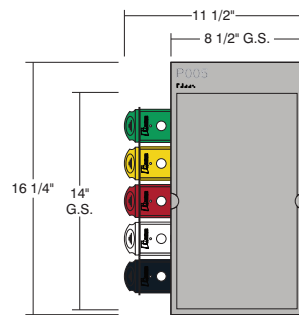

APFH-F8516-5

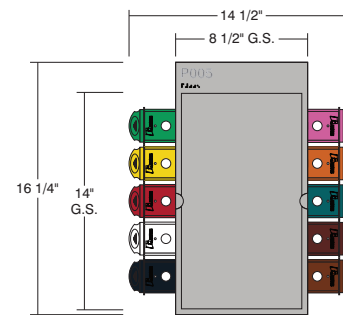

APFH-F8516-10

Drawing #	PF Standards
Date	10.8.18
Scale	1 1/2" = 1'
Drawn By	TWG

Approved _____



6" x 6" Graphic Size

PF Standards

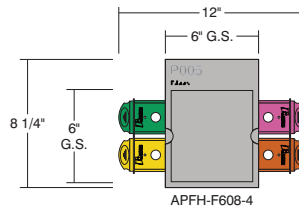
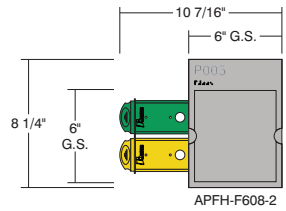
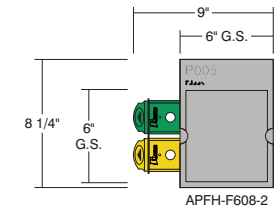
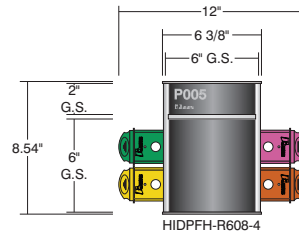
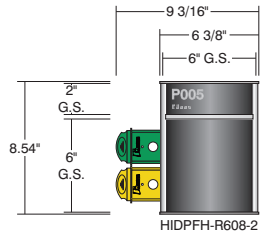
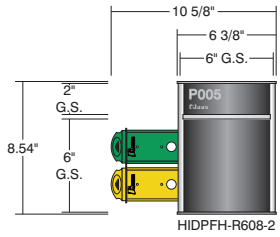
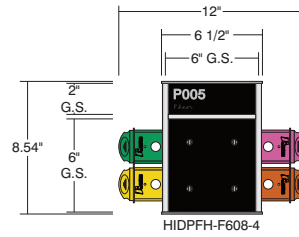
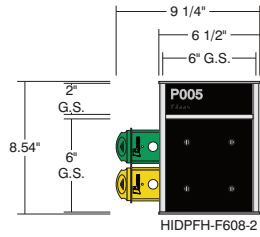
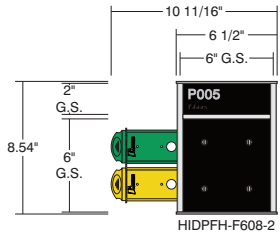

Drawing #	PF Standards
Date	10.8.18
Scale	1 1/2" = 1'
Drawn By	TWG

Approved _____



9" x 6" Graphic Size

PF Standards

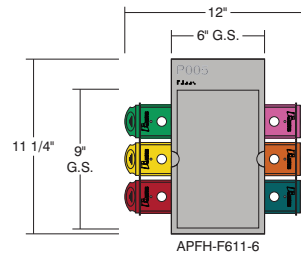
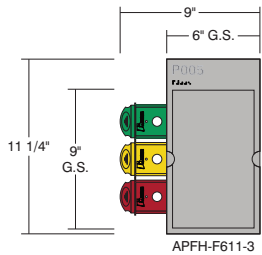
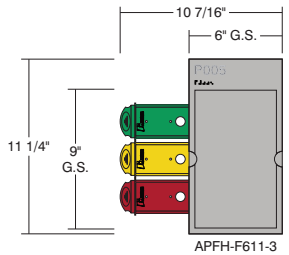
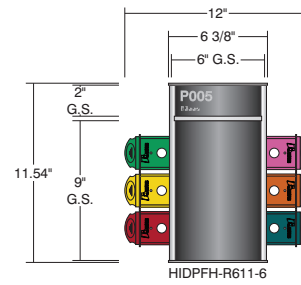
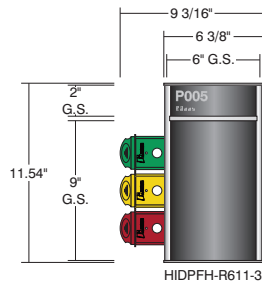
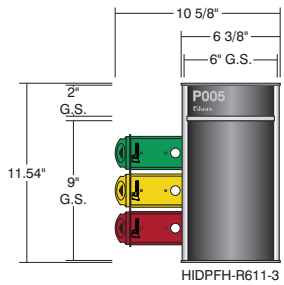
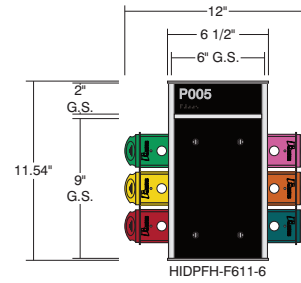
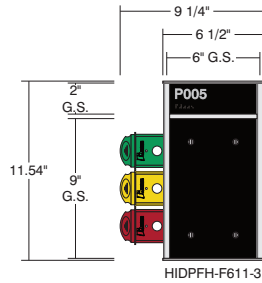
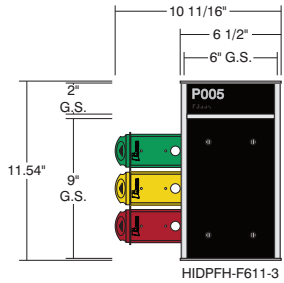

Drawing #	PF Standards
Date	10.8.18
Scale	1 1/2" = 1'
Drawn By	TWG

Approved _____



11" x 6" Graphic Size

PF Standards

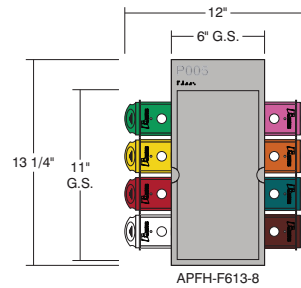
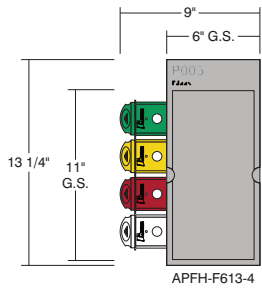
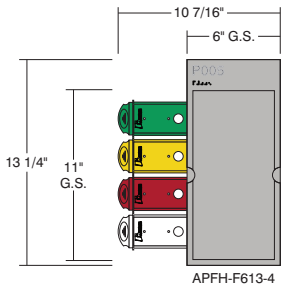
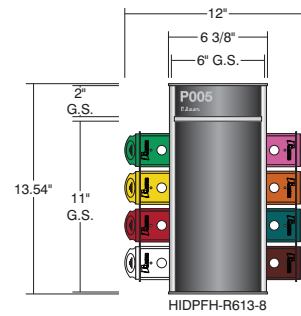
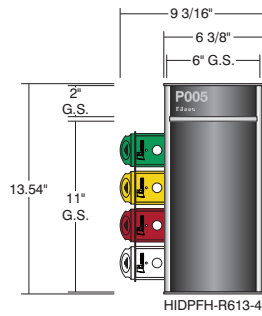
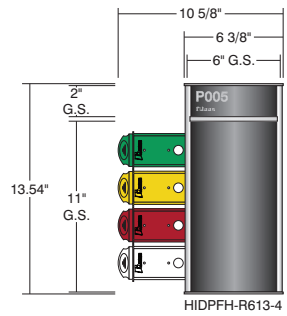
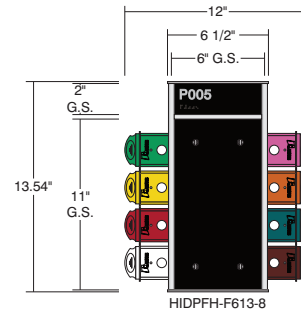
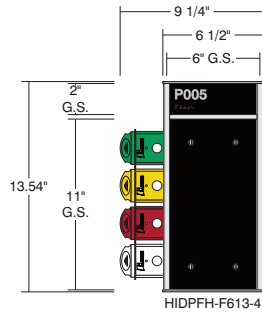
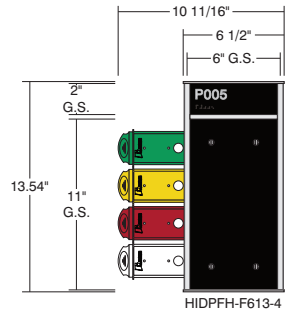

Drawing #	PF Standards
Date	10.8.18
Scale	1 1/2" = 1'
Drawn By	TWG

Approved _____



14" x 6" Graphic Size

PF Standards

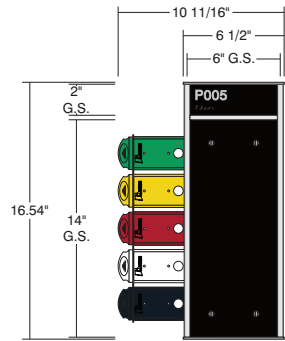

HIDPFH-F616-5

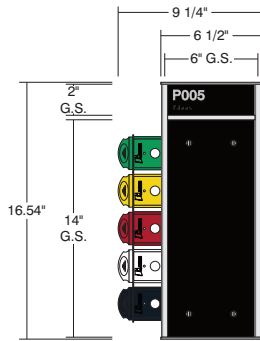

HIDPFH-F616-5

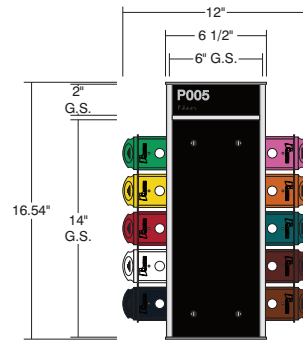

HIDPFH-F616-10

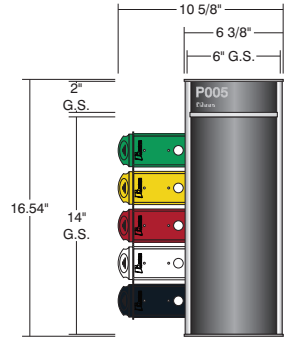

HIDPFH-R616-5

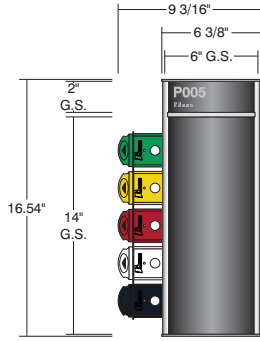

HIDPFH-R616-5

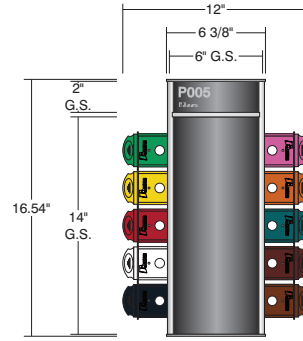

HIDPFH-R616-10

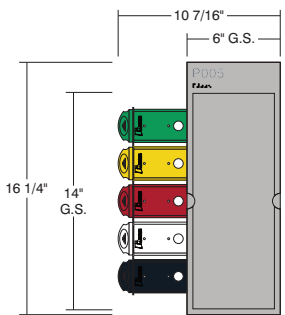

APFH-F616-5

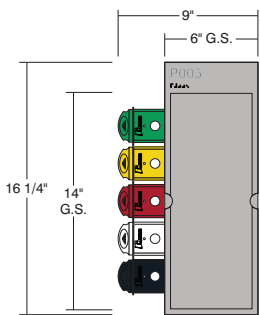

APFH-F616-5

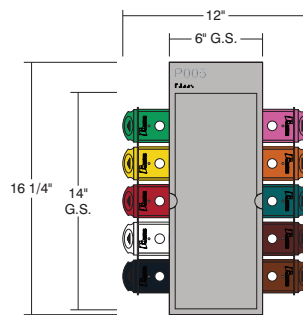

APFH-F616-10

Drawing #	PF Standards
Date	10.8.18
Scale	1 1/2" = 1'
Drawn By	TWG

Approved _____



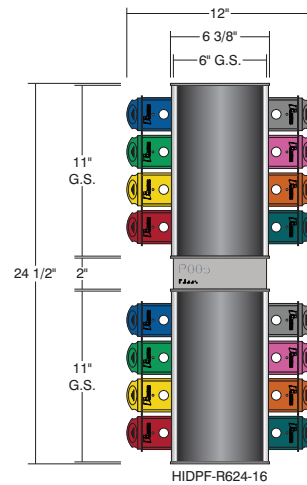
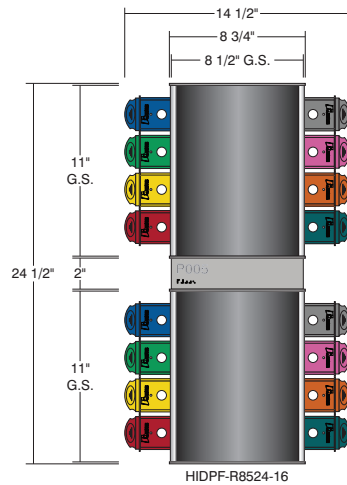
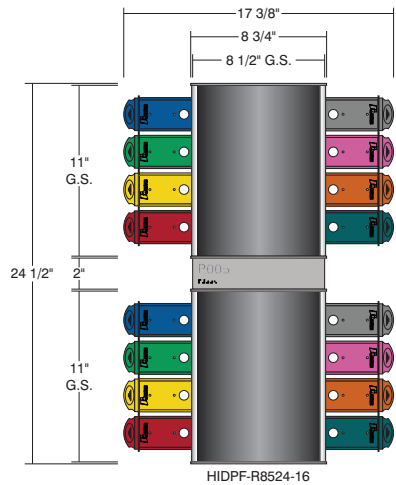
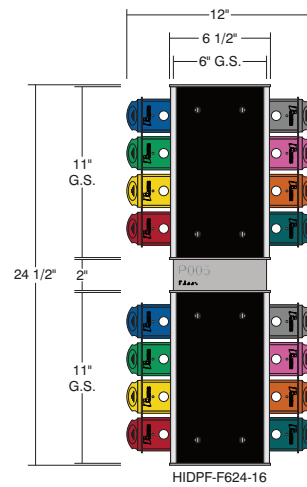
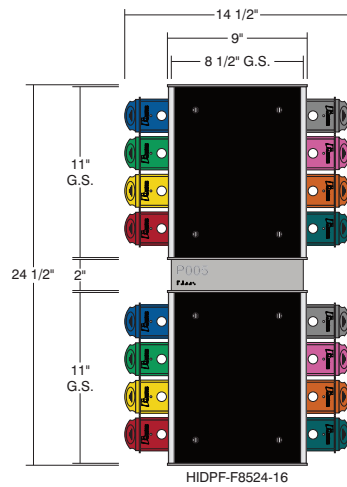
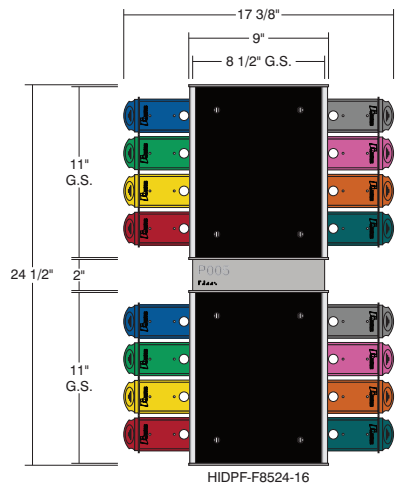

Drawing #	PF Standards
Date	10.8.18
Scale	1 1/2" = 1'
Drawn By	TWG

Approved _____



Double Occupancy & Paper Holders

PF Standards

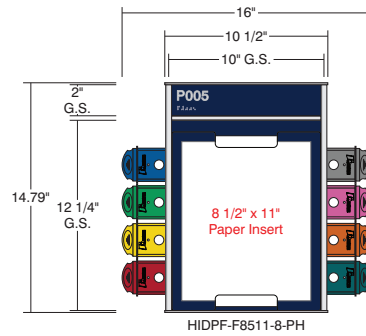
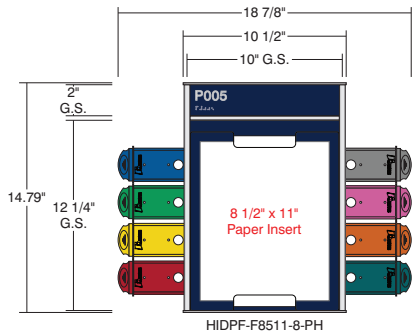
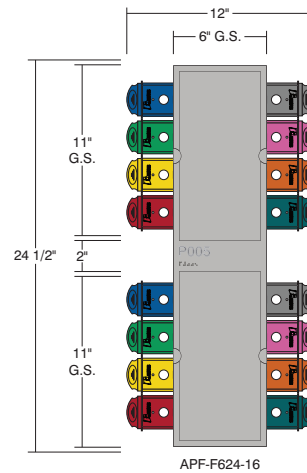
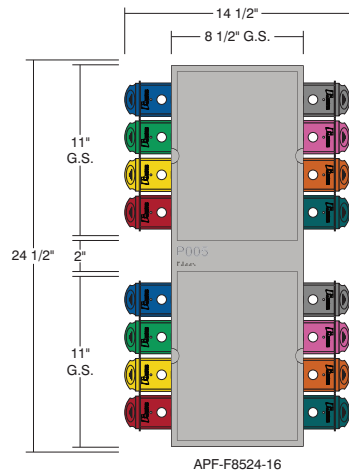
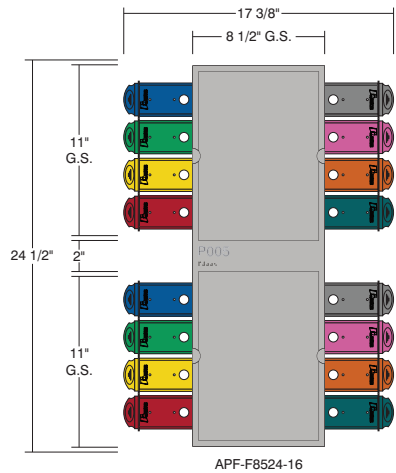

PAGE 18 OF 18

Drawing #	PF Standards
Date	10.8.18
Scale	1 1/2" = 1'
Drawn By	TWG

Approved _____

